

October 2018-The First Word



Generosity Fall Festival

Sunday, October 7, 2018

*"That's what I consider true generosity:
You give your all, and yet you always
feel as if it costs you nothing."*

— Simone de Beauvoir

A few things I have enjoyed observing about generous giving and living at First Lutheran.

First, tater tot hotdish, pans and pans of them lined up ready to go into the oven at funerals. Notice how many t's (crosses) are found in tater tot.

Second, a generous young youth in our congregation during offering. He stood before the mission globe, took out his wallet, reached in, took out money, put it in the globe, closed his wallet and put it back in his pocket before he sat back down.

Third, I recently was told one of our smallest children took all the green money out of his piggy bank to bring to church to offer.

Fourth, people helping other people who need rides to appointments or to church.

Fifth, parents volunteering to spend time on Wednesday nights with our confirmation youth as small group leaders.

Sixth, a willingness to help get things that fly out of our sanctuary. And more.....

My grandma always told me not to hang onto anything material too tight and to always be willing to give it away. She said, you will never need anything if you first give it away. Blessings! Pastor Julie

"Give, and it will be given to you. Good measure, pressed down, shaken together, running over, will be put into your lap. For with the measure you use it will be measured back to you."

Luke 6:38

Join in the opportunity to serve
at Feed My Starving Children
Saturday November 3rd, 9:00-11:00am



990 Lone Oak Road, Eagan, MN
Sign-up on-line at volunteer.fmssc.org
scroll down to "join a group"
Group Name: First Lutheran Church,
Join Code:1475131



**Lutheran Disaster
Response** strives to
help the church
continue to be church
in the midst of disaster

— following Christ's call to bring hope
and healing to our neighbor in need. Some
key areas of work include:

- Providing emotional and spiritual care for people who have been affected by a disaster and for leaders who respond to a disaster
- Coordinating volunteers through our local affiliates
- Assisting refugees in a holistic way by meeting the varied needs of the community
- Promoting disaster risk-reduction by helping communities build their assets thereby reducing the effects of likely disasters
- Providing long-term recovery efforts by addressing the unmet needs months or even years after a disaster strikes

First Lutheran is taking donations to be sent to LDR. Make checks to First Lutheran and add Hurricane Florence to the memo. THANK YOU!!!

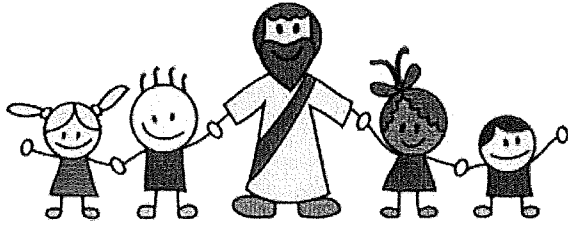

The presence of children is a gift to the Church they are a reminder to us that we are growing and welcoming all of God's people. Please welcome our parents and children, give a smile of encouragement.

TO PARENTS: Relax! God put the wiggles in children; don't feel you have to suppress it in God's house. **All are welcome!**

Sitting toward the front can help children see and hear what's going on during worship.

Communion Pew Card Question

Our constitution says you only need to fill out a communion card only one time a year. Thank you.



Fall Festival

Sunday, October 7th

**9 a.m. Worship followed by
Brunch and Silent Auction**

Please plan to attend!

***Get your auction items into the
church office ASAP.**

Help the Confirmation Students Complete some Hospice Kits!

The Confirmation students are going to make hospice kits for Global Health Ministries. Each kit costs about \$20 to make, and although we already received a Thrivent Grant to purchase some of the items, we need your help making complete kits! You can help out by purchasing any of the following items and bring them to church. The store brand of any of these products works just fine, and in fact will give you more bang for your buck! You can find all of the products listed below at Target or Walmart. If you have any questions, you can talk with Pastor Julie, or contact Intern Pastor Sara at smartin002@luthersem.edu.

Items Needed for Hospice Kits:

- 42 unscented bars of soap
- 79 jars of petroleum jelly (4 oz or larger)
- 63 pick style combs (they come in a pack of 3 at Target)
- 74 bath towels 50"-52" long (*Room Essentials Everyday Bath Towel* from Target would work great!)
- 36 wash cloths
- 70 nail clippers
- lots of band-aids (regular size, fun prints are welcome!)
- 86 pairs of household gloves (the reusable ones, size M)

Thank you for your help and support!

First Evangelical Lutheran Church Council

8:00 pm, September 19, 2018

(Minutes unofficial until approved at October Council meeting)

Welcome and Call to Order: Pat S.

Present: Amy Lee, Kevin Kruger, Wayne Spidahl, Candy Herrlich, Don Herrlich, Jill Berg, Pastor Julie.

Devotions: Pastor Julie

Adopt Agenda with additions: M/S: Don,/Wayne/Approved

-- Additions to agenda: Fall Festival update, November 21 Council Meeting, Budget Meeting

-- Letter from Synod approving constitution updates (the letter will be printed in its entirety in the October newsletter)

Secretary's Report: No corrections or additions. M/S: Candy/Kevin/Approved

Treasurer's Report:
-- Checks for August: \$15,747.89

-- Checking Account Balance August 31, 2018: \$3,180.20; M/S: Don/Amy/Approved

Pastor's Report:

Continuing With: Worship services, visits (hospital , communion, other – 15) weekly planning with Annette, weekly text study, supervision of Intern Pastor Sara, KW Pastors continuing conversations about collaborating, clergy coaching, First Lutheran will host Cannon river Conference Pastors meeting on January 3, 2019, confirmation classes,.

Looking forward: Vacation time in New York to visit Jenna, Oct. 14-22nd, confirmation retreat for 10th graders on Oct. 13th, Confirmation on Oct. 28th, intern supervisor and intern retreat, Oct. 25-26th, fall theological retreat Nov. 4-6.

Pondering: Christmas Day with Holden and Dale, worship assistants and how best to communicate with them. May need to use more than the newsletter to let people know they are being asked to greet, read, or assist with serving communion on a particular Sunday.

Continuing and New Business:

Website Update-Pastor Julie: Great work with Jim Braaten, continue to work on content.

New Website address: www.flckenyon.org

Tuck pointing loan update-Don and Kevin-- Tuckpoint Loan Update: Balance: \$6,000 (\$3000 paid off since September 1, 2018

Things That Fly-Pastor Julie

-- Property and management are on top of this. Any questions, please ask one of them.

Collaborative Christmas Day Service-Pastor Julie

-- Working with Holden and Dale to hold joint **Christmas Day** Service. Watch for Details

Fall Festival: Worship, followed by brunch and silent Auction. The letter from SEMN Synod approving our constitution is on a separate page of this newsletter.

Committee Reports:

Worship Committee: Will use time and talent sheets collected at the Fall festival for a current list of people willing to read, greet, and serve communion.

Communion Options:

1st Sunday – Kneel at table

2nd Sunday – Intinction

3rd Sunday – Continuous with cups

4th Sunday – Intinction

5th Sunday – Intinction

Some Gunderson Gardens' residents are requesting to attend church at First at least once a month. We are working on getting people to help transport them. Please let Carol or Pastor Julie know if you can help with this.

Stewardship Committee:

Fall Festival with worship, brunch and silent auction. Please consider making a donation for the silent auction.

Education Youth Committee:

Fund raiser at Rose fest on August 18, \$640 raised and shared with Scouts. We are still in need of someone for Sunday School music. Third graders and Pre-K received their Bibles on September 16. Road ditch cleaning on October 3, 6:00-7:00, pizza after confirmation. Feed my Starving Children on November 3 from 9-11:00, 25 spots available.

Kenyon Area Intern Committee

Three new members, Cindy Lewis from First Lutheran, Mark Christenson from Holden, and Christine Morland from Trinity, West Concord. Election of officers: Jim Fountaine, President; Rebecca Patterson, Vice-President; Bruce Kvittem, Treasurer, and Skip Voge, Secretary.

Committee and others helped Intern Sara move to Kenyon. Bruce reported that the budget looks good going into next year. There is no projected increase in the quarterly payments by the churches as the synod did not make any increases.

Property and Management Committee:

- Discussed Frontier phone contract
- Met with school monument committee
- Dealt with flying 'critters' in the sanctuary.

FLCW: See separate report.

Next Meeting Date: October 17, 2018 (VP Bill Lewis will preside)

Devotions: Bill Lewis

Adjournment: M/S Don/Jill/Approved

From the Intern Sara Martin

It's hard to believe about a month ago I started my internship with you all! It seems like just yesterday I moved into the apartments in Kenyon, and was trying to find where things were packed. Thank you to all of you who have helped me feel welcome in this unique internship. From helping me move, to supplying me with the random things I never thought I'd need to own, to introducing yourselves multiple times, and inviting me to take part in the life of your congregation, it means a lot to me. Now that I think I've found a rhythm, and know where all the churches are located, I think I'm in for a real treat! I am excited to learn from you all, to grow with you all, and to try new things with you all.

I am already starting to think about my internship project. So, be on lookout in bulletins, church announcements, and newsletters for information regarding gathering times/locations for a fellowship group with all eight churches. While it is still in the works, I am looking at starting a group that would meet about once a month (maybe more depending on interest!) to work on different hand projects together. Now this doesn't mean that we would necessarily all be working on the same project, but we would all bring different projects to work on in community. The best part is that this group would certainly be open to men and women, and there would be no expectation regarding what project you may work on. While there will likely be some activities available (knitting/crocheting patterns, coloring pages, and other small hand crafts) come even if you don't have something to work on! My hope would be that we could all learn from each other, and spend time together while working on projects we may have set to the side. As I start to finalize more of the details, I will be sure you get to hear about them! Feel free to invite your neighbors if they're interested as well!

I am looking forward to another month learning from you all!

Intern Pastor Sara

FLCW Board met on Tuesday,
September 4, 2018 at 7 PM.

Meeting called to order by Candy Herrlich.

Karen Fountaine gave devotions.

Secretary's report was read and placed on file.

Treasurer's report was presented and placed on file. Balance to date is \$1,398.75.

Correspondence received from Marie Sandvik Center, Katie's Fund and a thank you from Good Earth Village for the quilt donation.

Old Business:

Reminded to save used stamps and postcards.

Rally Sunday is September 9 with the theme God's work, our hands. Food drive at the church and the Bartlanders @Holden Park at 3:00 PM.

September 16th Pre-school and third grade Bibles. Beneke family will be here. Cindy and Jackie (nominating committee) are working in the FLCW booklet updates. Wedding Extravaganza will be September 30 at 4:30 PM. Program, lunch and set up discussed at length. Tammy will contact participants and Cora Lee will contact models and servers. Set-up September 29th at 9:30 AM. Members are to call the church office 789-5261, Cora Lee 789-6399 or Candy 789-6369 to make reservations. Mission: Stewardship is charge of lunch. Fall Festival will be October 7th. Silent auction to include new items, unusual items and services. There also be brunch. Confirmation service is scheduled for October 28th Thank Offering Service will be November 18. Lefse making will be November 8, 9, and 10 in the mornings.

New Business:

Altar Care meeting before November FLCW meeting at 6:15 PM. Sunday School Christmas shopping tentatively set for December 9th. Next meeting will be Monday, October 1 at 7 PM.

Cora Lee will give devotions.

The meeting was adjourns with the Lord's Prayer.

Respectively submitted by
Janice Ashland, Secretary

Ladies Clubs & Bible Study News

*Morning Circle Bible Study

First Tuesday of the month in the Joy Room. Everyone is welcome!

October 2nd meet at 9:30 a.m.

September–November 2018

This three-part Bible study by Meghan Johnston Aelabouni will explore how we as Lutheran Christians understand the role of repentance in our faith, especially as we understand God's grace to be *unearned* and *freely given*.



The Monthly Bible Study is found

in the "Gather" magazine.

To order this magazine through the

order center at Cambey & West

call 844-409-0576 (toll free)

or 845-267-3074

Gather Subscription Center PO Box 336

Congers NY 10920-0336

gather@cambeywest.com

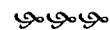

*Christian Mission

Thurs., October 11th, 1 p.m.

Thurs., October 18th, 1 p.m.

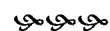

*Priscilla Club

Tues., October 9th, 1 p.m.

Jean Hiner is the hostess

Tues., October 23rd, 1 p.m.

Jeanne Ellingson is the hostess

Tues., October 30th, 1 p.m.

Cora Lee Monroe is the hostess

Lyn's Line or So....

"The only thing harder than waiting on God is wishing you had." Stephan Furtick

My interview this month is our volunteer Sunday School Superintendent for Pre-K through 6th grade. Approximately 40 kids are signed up at this time. Every Sunday 10-11 am.
All are welcome.

Bev K. Emerson

Born: St. Lucas Hospital in Faribault. Briefly lived in Boise, Idaho

Baptized: Hegre Church

Confirmed: April 11, 1965 on Palm Sunday at First Lutheran.

High School: Graduated in 1968 from Kenyon High School.

Married: The "Grand Marshal" of 2018 "Rose Days", Dave Emerson, in 1969. He is the owner of Emerson's Fine Furniture. They were high school sweethearts and classmates.

Education: St. Barnabas Hospital School of Nursing in Minneapolis. (3 years), St. Mary's Junior College (Cardiac Care), Augsburg College (Under Grad and Graduate School).

Work Experience: Intensive Care-Neuro and Cardiac Staff Development Coordinator and Infection Control Nurse, Community Mental Health Practitioner inpatient and outpatient settings.

Children: One son Christopher and wife Christa who live in Corcoran, MN.

Grandchildren: Porter age 10 and Hadley age 8.

BFF: Duke, our yellow English Lab who is 3 years old. (Also several humans!)

Special Interests: Travel, music, read a book a week, writing, "learning" to quilt, and mowing the lawn.

Greatest Accomplishments: Nursing degrees and surviving...

Plans for the future: adjusting to retirement, breast cancer support group leader, convince Dave to retire, travel, see grandkids more often!

Favorite Bible verse: Hebrews 13:2 "Be not forgetful to entertain strangers for thereby some have entertained Angels unawares."

See you in church.

Lyn Cole Clarke

New Free Exercise Program for Older Adults

Stay Active and Independent for Life (SAIL) is a free exercise class available for local seniors Tuesdays and Thursdays each week from 9:30 to 11:30 a.m. at St. Michael's Catholic Church in Kenyon. The hour long classes include low impact aerobics, balance exercises, strength training with hand and ankle weights and stretching exercises. The program is able to accommodate people with a mild level of mobility up to those who are regularly active. The exercises focus on improving flexibility, bone and muscle strength, balance and overall fitness. A natural outcome of these fun new classes is the beneficial social interaction provided along with the exercise. Classes are led by trained volunteers and all needed equipment is provided. It is suggested that participants attend both days for the most benefit. For more information regarding this program, contact Michael Maas, Active Aging Programs Administrator at (507) 450-1518 or email at mmaas@ccsommn.org.



Southeastern Minnesota Synod
Evangelical Lutheran Church in America

God's work. Our hands.

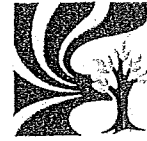

July 16, 2018

Tammy Fletcher
First Evangelical Lutheran Church
309 Forest St
Kenyon, MN 55946-1132

Dear Tammy,

At its meeting on July 16, 2018, the Synod Council of the Southeastern Minnesota Synod approved the constitution of First Evangelical Lutheran Church, Kenyon. The following action was adopted:

Council Action:

- to thank First Evangelical Lutheran Church, Kenyon, for the work done on the constitution and bylaws;
- to express appreciation for the way the congregation bylaws have been codified in the document as a model for other congregations in the synod; and
- to approve the constitution approved January 28, 2018, and ratified February 18, 2018, as consistent with the *2016 Model Constitution for Congregations of the Evangelical Lutheran Church in America* and the constitutions of the Evangelical Lutheran Church in America and the Southeastern Minnesota Synod.

Thank you for your attention to your constitution and bylaws.

Sincerely,

Jodie Archer
Synod Secretary
Southeastern Minnesota Synod, ELCA

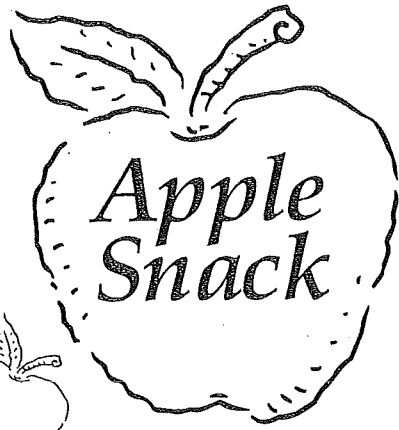

You will need:

- a small bowl
- a spoon
- 1/4 cup peanut butter
- 2 Tbsp. raisins
- 1 Tbsp. honey
- 3 apples
- lemon-lime soda

How to make:

- 1 Mix peanut butter, raisins and honey in the bowl.
- 2 Get a grownup to help you cut the apples in half lengthwise and remove the cores.
- 3 Dip the cut part of the apple in the soda so the apple does not turn brown.
- 4 Fill the center of each apple half with the peanut butter mixture.

Cover and refrigerate.

Enjoy!

Makes 6 servings.

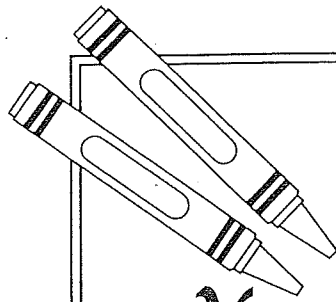

Just for **KIDS**

You are very special and important to God!

In Zechariah 2:8, Deuteronomy 32:10, Proverbs 7:2 and Psalms 17:8, we find an expression that describes how special and important you are to God. Use the picture graph to fill the blanks.

You are

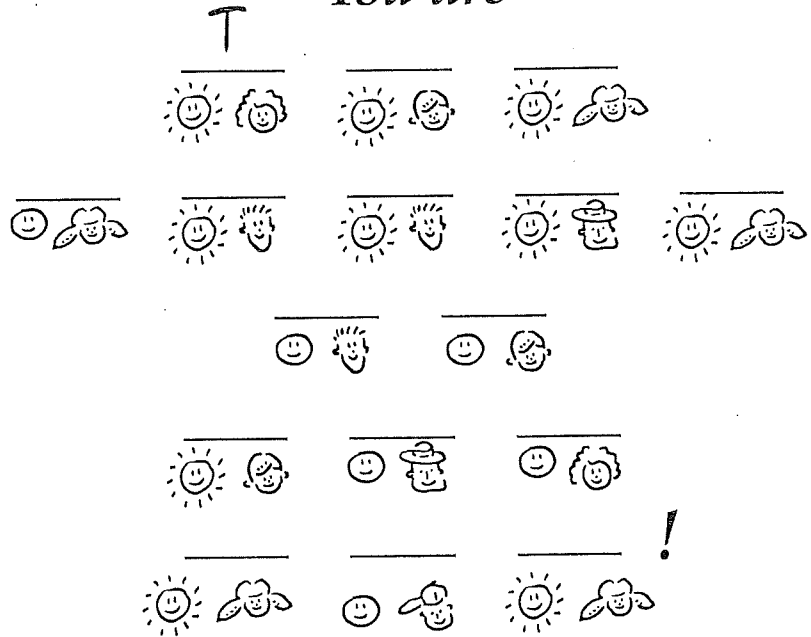

| | | | | | | |
|--|---|---|---|---|---|---|
| | A | F | I | O | S | Y |
| | E | H | L | P | T | Z |
| | | | | | | |

The apple of His eye!

| Sun | Mon | Tue | Wed | Thu | Fri | Sat |
|---|---|--|---|--|---|---|
| | <p>1 7:00 FLCW Board</p> | <p>2 9:30 Morning Circle Bible study 5:30 Worship/ Evangelism @ Gunderson Gardens</p> | <p>3 6:00 Worship 6:00 Confirmation- Ditch Cleaning with Pizza afterwards</p> | <p>4 9-12 Cannon River Ministry @ Goodhue</p> | <p>5</p> | <p>6 <i>Daniel Larkin/Kayla Durst Wedding Off Site</i></p> |
| <p>7 <i>Fall Festival</i> 9:00 Worship followed by Brunch and Silent Auction Stewardship Committee</p> | <p>8 5:30 Property & Management</p> | <p>9 1:00 Priscilla Club</p> | <p>10 5:30 Ed Youth Committee 6:00 Worship 6:30 Confirmation 7:00 Senior Choir</p> | <p>11 1:00 Christian Mission Society Love Day</p> | <p>12</p> | <p>13 4:00-7:00 Confirma- tion Retreat</p> |
| <p>14 9:00 Worship 10:00 Coffee 10:00 Sunday School</p> | <p>15</p> | <p>16</p> | <p>17 6:00 Worship 7:00 Senior Choir 8:00 Church Council</p> | <p>18 1:00 Christian Mission Society Love Day 6:00 Sons of Norway</p> | <p>19</p> | <p>20</p> |
| <p>21 9:00 Worship 10:00 Coffee 10:00 Sunday School</p> | <p>22 <i>Newsletter Information Deadline</i></p> | <p>23 1:00 Priscilla Club 7:00 Internship Committee @ First</p> | <p>24 6:00 Worship 6:30 10th grade Confirmation Re- hearsal & Dinner</p> | <p>25 Internship Mount Olive</p> | <p>26 Retreat Retreat Center</p> | <p>27</p> |
| <p>28 <i>Confirmation</i> 9:00 Worship with Affirmation of Baptism 10:00 Coffee 10:00 Sunday School</p> | <p>29</p> | <p>30</p> | <p>31 <i>Happy Halloween</i> 6:00 Worship 6:30 Confirmation 7:00 Senior Choir</p> | | <p>October 2018</p> | |

The First Word

floffice@frontier.com
Web Site www.flckenyon.webs.com
First Evangelical Lutheran Church
309 Forest St.
Kenyon, MN 55946
(507)789-5261
*Change service requested

Presorted
Standard
U. S. Postage
PAID
Kenyon, MN
Permit No. 20

First Evangelical Lutheran Staff

| | |
|---------------------|---|
| Pastor | Julie Rogness |
| Intern | Sara Martin |
| Secretary | Debbie Eggert |
| Accountant | Julie Dyrdahl |
| Custodians | Dave & Betty Redfield |
| Keyboardists | Annette Thunhorst, Tammy Hanson |
| Choir Director | Carol Lozon |
| Bell Choir Director | Tanya Short |
| Missionaries | Stephen Deal, Patrick & Jacqueline Bencke Karen Anderson |

Mission Statement of First Evangelical Lutheran Church

“Through God we are creating a vibrant, welcoming faith community, embracing all, providing harmony among generations, while lending compassion locally and globally.”

Volunteers for October -Ushers

Jerry Berg, chr.
Tim Sackett, chr.
Mike Berg
David Schreiber
Russ Foss
Mel Kirchhoff
John Lang
Jeff Traxler
Ryan Ugland

Altar Care

Rhana Olson
John & Debi Maki
Linda Barsness
Marcy Gaasedelen

Communion Set-up

Oct. 7: Paul & Sharon Rectzigel
Oct. 21: Larry & Carolyn Walker

Communion Helpers, Acolytes, Coffee Servers:

October 7: Fall Festival

Reader-Steve Alger
Greeter-Jerry & Jill Berg
Com.- Jim & Karen Fountaine, Steve Alger
Acolyte: Ashley Rechtzigel, Reganne Androli

October 14:

Reader-Sue Fogelson
Greeters-Don & Candy Herrlich
Com.-Ed & Tammy Fletcher, Sue Fogelson
Coffee-Don & Candy Herrlich
Acolyte-Josi Quam, Emma Paulson

October 21:

Reader-9th graders
Greeters-9th graders
Com-Tim & Ellen Sackett, Sue Wold
Coffee-Ken & Sue Wold
Acolyte- Corrie Born, Julia Dahl

October 28: Confirmation Service

Reader- Confirmands
Greeters-Confirmands
Com.-Candy Herrlich, Rhana Olson,
and Harris Haugen (confirmation
mentors)
Coffee-Gary & Mary Skundberg
Acolyte-Leah Berg, Stella
Rechtzigel

